

Building a portable data and information interoperability infrastructure—framework for a standard Taiwan Electronic Medical Record Template

Wen-Shan Jian^{a,b,f}, Chien-Yeh Hsu^c, Te-Hui Hao^d, Hsyien-Chia Wen^b, Min-Huei Hsu^c, Yen-Liang Lee^e, Yu-Chuan Li^{f,**,1}, Polun Chang^{f,*,1}

^a Institute of Public Health, National Yang-Ming University, Taipei, Taiwan

^b School of Health Care Administration, Taipei Medical University, Taipei, Taiwan

^c Graduate Institute of Medical Informatics, Taipei Medical University, Taipei, Taiwan

^d Department of Business Administration, Chang Gung University, Taipei, Taiwan

^e Department of Information, Kangning Hospital, Taipei, Taiwan

^f Institute of BioMedical Informatics, National Yang-Ming University, Taipei 11221, Taiwan

ARTICLE INFO

Article history:

Received 11 January 2007

Received in revised form 6 July 2007

Accepted 30 July 2007

Keywords:

TMT

EMR

EHR

Template

Schema

Standard

ABSTRACT

Traditional electronic health record (EHR) data are produced from various hospital information systems. They could not have existed independently without an information system until the incarnation of XML technology. The interoperability of a healthcare system can be divided into two dimensions: functional interoperability and semantic interoperability. Currently, no single EHR standard exists that provides complete EHR interoperability. In order to establish a national EHR standard, we developed a set of local EHR templates. The Taiwan Electronic Medical Record Template (TMT) is a standard that aims to achieve semantic interoperability in EHR exchanges nationally. The TMT architecture is basically composed of forms, components, sections, and elements. Data stored in the elements which can be referenced by the code set, data type, and narrative block. The TMT was established with the following requirements in mind: (1) transformable to international standards; (2) having a minimal impact on the existing healthcare system; (3) easy to implement and deploy, and (4) compliant with Taiwan's current laws and regulations. The TMT provides a basis for building a portable, interoperable information infrastructure for EHR exchange in Taiwan.

© 2007 Elsevier Ireland Ltd. All rights reserved.

1. Background

The data sources of a tradition electronic health record (EHR) are from various hospital information systems. They are not stored independently without the support of hospital information systems until the incarnation of XML technology.

The sharing of data among healthcare organizations not only imposes functional demands of the exchange but requires semantic communication as well. Usually, people develop standards and technology to achieve the above interoperability of data sharing. There are currently many standard development organizations (SDOs), such as Health Level Seven (HL7) [1] and Integrating the Healthcare Enterprise (IHE) [2],

* Corresponding author. Tel.: +886 2 2826 7238.

** Corresponding author. Tel.: +886 988262639.

E-mail addresses: polun@ym.edu.tw (P. Chang), jackli@ym.edu.tw (Y.-C. Li).

¹ These authors contributed equally to this work.

and (4) compliant with Taiwan’s current laws and regulations.

4.1. Transformable to international medical information standards

The Taiwanese EHR format must be compatible with international medical information standards. We reviewed HL7 CDA, the most famous EHR exchange standard in the world. We obtained the following recommendation from The Clinical Document Architecture Release 2.0. The CDA is an exchange

specification, not an authoring specification. HL7 suggests the general approaches for EHR exchange [1]:

“General approaches: constrain or transform

- constrain: emit valid CDA directly from the authoring system using a schema that isn’t CDA
- transform: example - emit local XML, map to CDA.”

For technical considerations, the team used the transformation approach for the TMT so that it will be transformable to CDA as seen in Fig. 1.

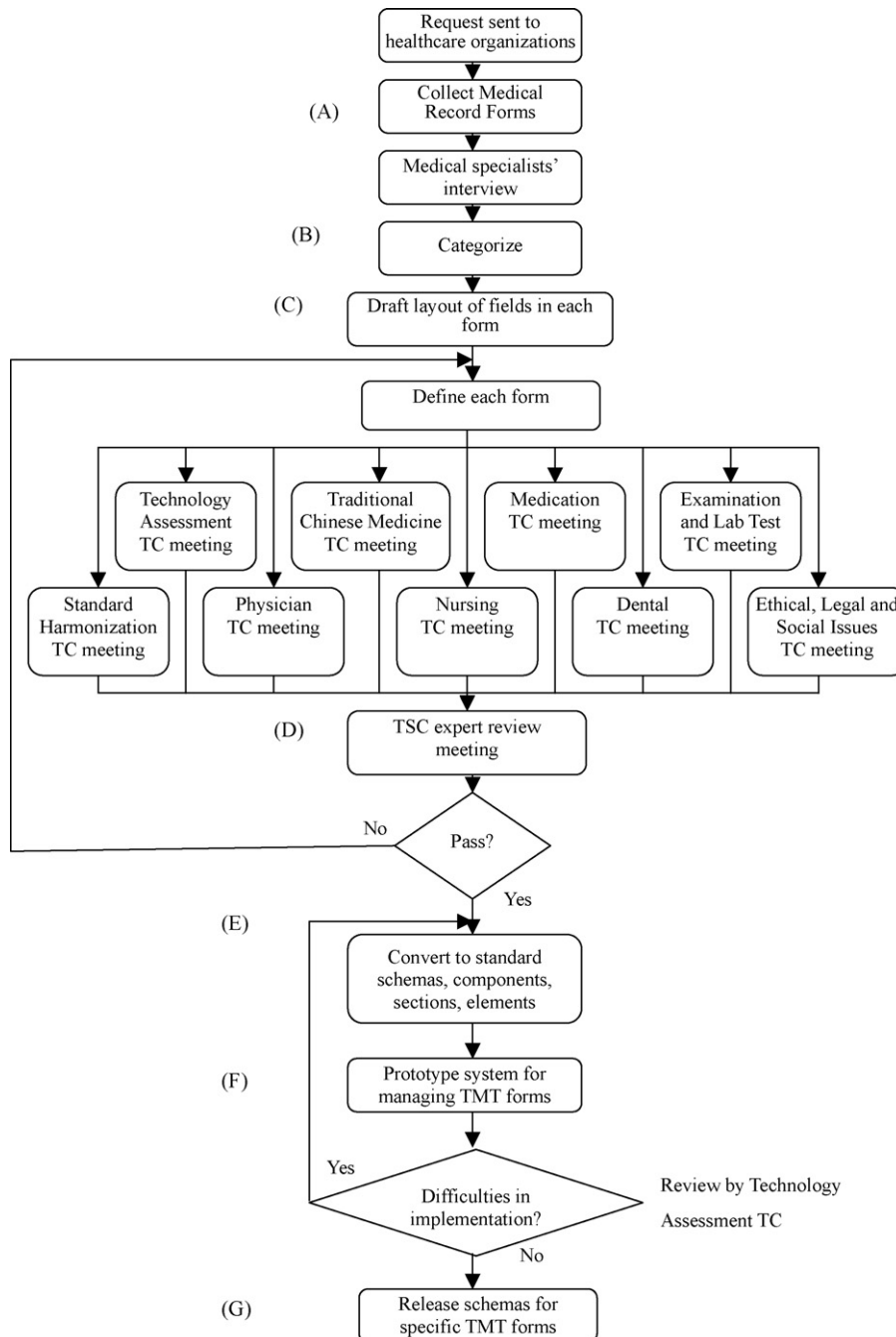

Fig. 2 – Description of the process used for defining the TMT contents.

4.2. Having a minimal impact on existing healthcare systems

In order to easily integrate into the current healthcare environment, the TMT was designed to use forms as self-contained units, which are already commonly used by medical professionals.

A request was sent to 598 hospitals nationwide, and 200 hospitals responded providing as many as 20,056 forms which encompassed almost all the different forms that can be found in a hospital.

The process of defining the TMT standard was composed of (A) collecting and examining forms by medical specialists, (B) classifying the over 20,000 forms into 70 categories based on their similarities, (C) drafting TMT format proposals by the research team, (D) meeting with experts to form a consensus, (E) encoding the TMT schema with reusable components, (F) building a prototype system for managing the TMT forms, and (G) releasing a schema for specific TMT forms.

The released draft proposal uses the common request for comments (RFC) approach to solicit comments from the public. Meetings were often held to try and arrive at a consensus for a specification that minimized difficulties and criticisms. We held nine technical committees (TCs), including those for Physicians, Traditional Chinese medicine, Nursing, Medications, Dental, Examinations and lab tests, Technology assessments, Standard harmonization, and ethical, legal, and social issues (ELSI). A technical steering committee (TSC) was set up along with multiple technical committees in each field. The TSC itself was comprised of about 30 experts (including all the chairs and co-chairs of each TC) who had the responsibility of directing and approving work on all final documents (Fig. 2).

Through collecting data, drafting the TMT standard, reviewing by experts, defining the TMT standard, studying related international standards, and accounting for conversion of standards, the TMT architecture was developed which utilizes the modality of forms, components, sections, and elements to arrive at a TMT schema from the real world. By creating a system prototype and carrying out revisions, the resulting standard more closely matches the requirements of real-world applications.

After 3 years of development, the TMT is now up to version 2.0. It currently includes 70 EHR forms that are the building blocks of an EHR. The TMT is defined to present the state of an EHR at a single point in time, i.e., a snapshot of the medical record at a specific point in time and to enable the sharing of EHRs between facilities. The TMT is an EHR template for functional interoperability and semantic interoperability. It does not affect a hospital's process of creating the EHR, the internal document flow, or documentation of management messages.

4.3. Easy to implement and deploy

Our team is carrying out an evaluation project to validate the practicability of the TMT standard. The team evaluated three different levels of healthcare organizations to participate in the prototyping of the TMT system: a 650-bed medical center

(Wanfang Hospital, Taipei); a 200-bed local hospital (Kangning Hospital, Taipei); and a clinic (Shinhe Clinic, Taipei). The preliminary results showed that in electronically sharing over 40,000 medical sheets in the TMT forms within 1 week, no mapping errors occurred.

4.4. Compliant with current laws and regulations

Legal professionals were invited to review all relevant laws which might pertain to the deployment of TMT in Taiwan, including the Medical Care Act, Physician Act, Computerized Personal Information Act, Electronic Signature Act, Personal Data Protection Ordinance, and Healthcare Organization Electronic Medical Record Creation and Management Ordinance. They concluded that the TMT can be deployed in a way compliant with all existing Taiwanese laws and regulations.

5. The framework of the TMT

To reduce the complexity of the TMT and to take into account difficulties with practical implementation, the basic principle in the design of the TMT formats was to develop a set of templates for representing the EHR contents at a certain point in time.

The focus was on the format for presenting the data contents. TMT documents were therefore designed to be a snapshot of the medical record at a certain point in time.

A basic building block of the TMT is its forms. When we create a patient's EHR using the TMT standard, we generate sheets from each TMT form. The following paragraph provides the definitions for forms and sheets.

1. *TMT form*: Traditional paper forms such as outpatient notes, prescriptions, and test reports are treated as TMT forms. Each TMT form is represented as a single XML schema. Each form has its own corresponding schema defining its structure and content.

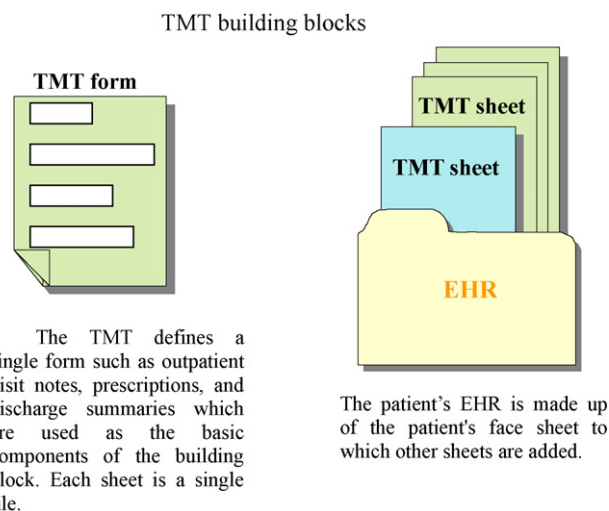

The TMT defines a single form such as outpatient visit notes, prescriptions, and discharge summaries which are used as the basic components of the building block. Each sheet is a single file.

The patient's EHR is made up of the patient's face sheet to which other sheets are added.

Fig. 3 – Forms and sheets in the Taiwan Electronic Medical Record Template (TMT).

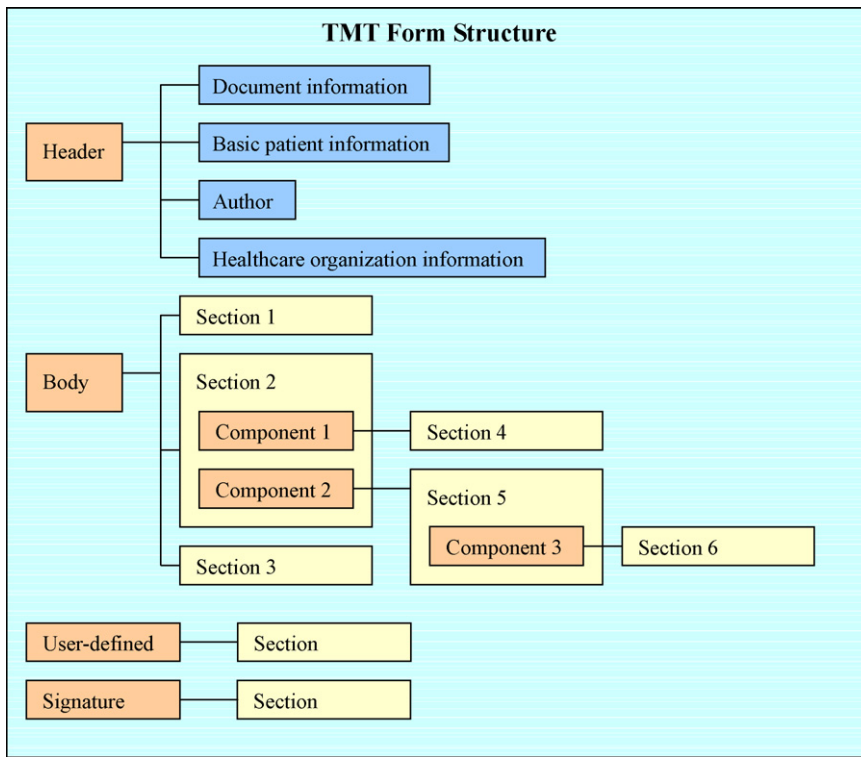

Fig. 4 – Taiwan Electronic Medical Record Template (TMT) form structure.

2. TMT sheet: A sheet is an instance of a TMT form. Hence, a sheet is an XML file that contains data in a specific form.

The TMT standard is composed of multiple schemas representing different forms in a medical record.

XML schemas [14] express shared vocabularies and allow machines to carry out rules made by people. They provide a means for defining the structure, content, and semantics of XML documents. There are currently more than 70 different TMT forms such as outpatient visits, lab reports, prescriptions, admission notes, etc. Each patient's EHR will then contain multiple TMT sheets, which are instances of the previously described TMT forms (Fig. 3).

6. The anatomy of a TMT form

Each TMT form is composed of four major parts: a header, body, user-defined section, and signature (Fig. 4).

6.1. Header

The header stores four different kinds of information, namely, the document information, basic patient information, author, and healthcare organization information. The document information contains items such as document ID, submission ID (for document grouping), and set ID (for version

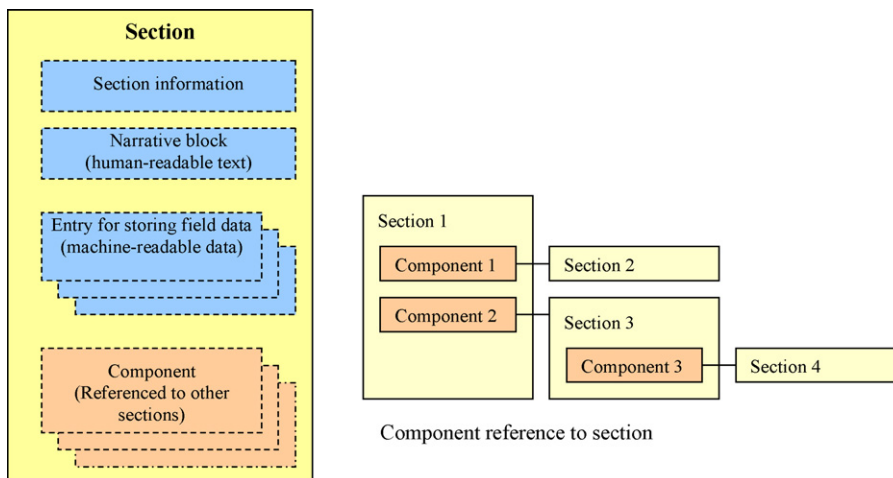

Fig. 5 – The framework of TMT component section.

control). The basic patient information contains patient ID, gender, age, emergency contact, etc. The author information represents the humans and/or machines that authored the document. Healthcare organization information is given on the healthcare organization which is in charge of maintaining the document.

6.2. Body

The body of each form is where the main information is stored. Different forms have different layouts, but they all follow the basic section-component structure described in Fig. 5.

6.3. User-defined section

This allows users to fit their own contents into a customized layout. The main function is to accommodate special data-capture needs of each organization. However, producing customized layouts could result in a lower level of interoperability.

6.4. Signature

The TMT form uses the W3C XML signature standard. This allows the incorporation of digital signatures of healthcare organizations and personnel.

6.5. Sections and components

The section is the main data structure in the body that include section information, a narrative block, entries, and components as shown in Fig. 5. The section information covers such things as section ID, code, title, author, etc. The narrative block carries the human-readable text, while the entries carry machine-readable data. The components represent references to other sections which can be reused and included in this specific section. The team has defined more than 40 reusable TMT sections such as a basic patient information section, past medical history section, allergy history section, family history section, etc. This reduces the amount of redundant re-definition required while simplifying the procedure needed to define each TMT form.

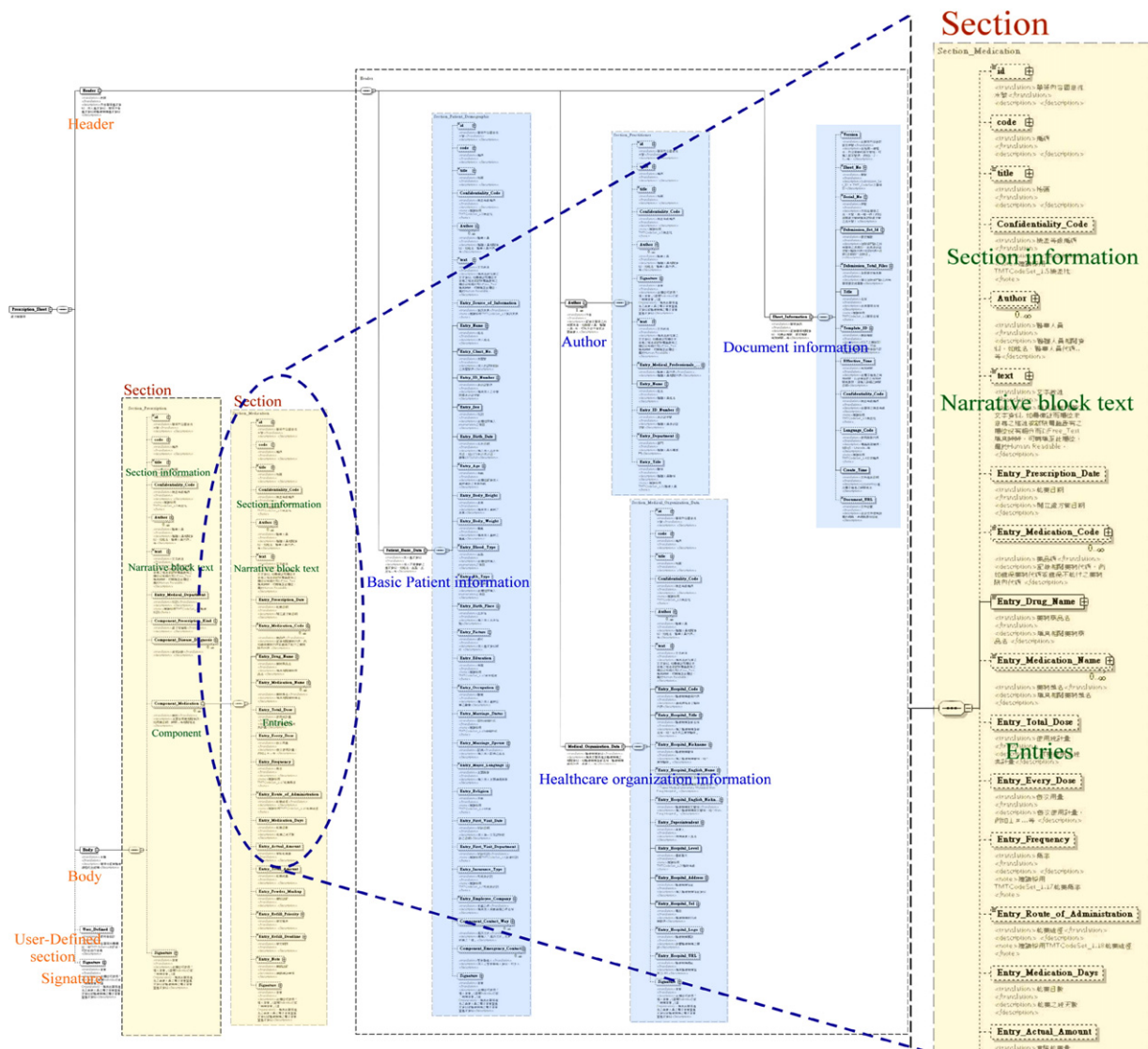

Fig. 6 – An example showing the schema of the Taiwan Electronic Medical Record Template (TMT) prescription form.

7. An example of a TMT form

The schema is an integral part of our EHR format definition. Through the use of the schema, users can quickly verify if a TMT sheet (an XML file) generated by the user conforms to our specifications.

TMT forms are modeled after traditional paper forms for medical records. So far, 70 TMT forms (schemas) have been completed, representing commonly used paper forms found in traditional medical records. An example of a prescription form representing the TMT schema is shown in Fig. 6. The schema of the prescription form is the simplest form of the TMT. Each form is composed of four major parts: a header, a body, a user-defined section, and signatures. The header includes sheet information, basic patient information, author, and healthcare organization information. The medication data section includes prescription date, medication code, medication name, total dose, unit dose, frequency, route of administration, etc. under the body section.

All 70 TMT forms are categorized into six major groups: outpatient, emergency, inpatient, nursing, reports, and others. The outpatient group, for example, includes a general outpatient encounter, progress encounter, dentistry encounter, Chinese medicine encounter, prescriptions, etc. A list of all TMT forms is given in Table 1.

8. The concept of a submission set

A submission set refers to a collection of all medical records generated during a given consultation or visit to a specific healthcare organization. For example, one outpatient consultation may include an outpatient note, prescription, and laboratory test application form. And so on, while each hospital stay may result in an admission note, progress notes, operation notes, nursing records, etc. The header of each sheet therefore includes a submission set ID along with the total number of sheets in that group of submission to ensure completeness of the data.

Each submission set can also be used as a unit for data encryption and/or a signature. This prevents the leaking of information from individual sheets leading to erroneous assumptions about the full contents of the EHR. A submission set can also include multimedia attachments such as JPEG, AVI, GIF, and other binary file formats (Fig. 7).

9. Comparison with other international EHR exchange standards from the user's perspective

Compared to other EHR exchange standards currently being developed, the TMT offers the following features.

Table 1 – Taiwan Electronic Medical Record Template (TMT) form classification

1. Outpatient	3. Inpatient
General outpatient encounter	Admission note
Medical outpatient encounter	Progress note
Surgical outpatient encounter	Inpatient medical order
Family medicine outpatient encounter	Consultation note
Gynecological outpatient encounter	Discharge summary ...
Pediatric outpatient encounter	
Otolaryngology outpatient encounter	4. Nursing
Dermatology outpatient encounter	Nursing problem record
Respiratory outpatient encounter	Hospitalization nursing assessment form
Orthopedics outpatient encounter	Nursing plan form
Optometry outpatient encounter	Nursing record
Anesthesiology outpatient encounter	Vital signs monitoring record
Psychiatric outpatient encounter	Emergency nursing assessment form ...
Neurosurgery outpatient encounter	
Neurology outpatient encounter	5. Test report form
Gastroenterology outpatient note	Checkup application form
Radiology outpatient encounter	Laboratory testing application form
Urology outpatient encounter	Checkup report
Dentistry encounter	Laboratory test report ...
Chinese medicine outpatient encounter	
Prescription sheet ...	
2. Emergency	6. Other
Emergency trauma surgery note	Patient health summary
Emergency triage form	Transfer sheet
Emergency assessment form	Anesthetization record
Emergency medical order ...	Nutrition consultation record
	Health education record
	Surgery consent form
	Ambulance record
	Health checkup report ...
	... May include various types of functional sheets.

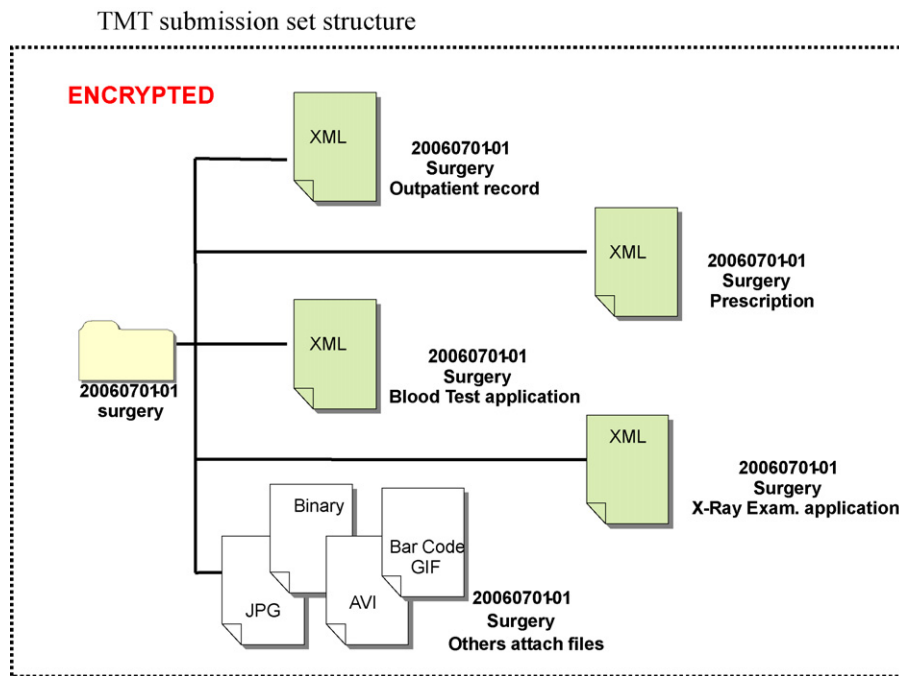

Fig. 7 – Taiwan Electronic Medical Record Template (TMT) submission set structure.

9.1. Clearly defined data storage

The TMT uses a form-based representation in which each form from paper-based medical records has its own specific schema. This creates a system framework containing multiple schemas. Because the way data stored in each sheet is clearly defined, users can quickly locate any information.

9.2. Rapid technical implementation

Because of the form-based representation, an EHR form can be developed which incrementally represents the entire EHR. They need thorough browser system prototyping, and revisions can be performed form-by-form. This therefore simplifies the new system design and deployment.

9.3. Ease of learning

A single schema that represents the entire EHR not only increases structural complexity but also makes it difficult to learn. With the TMT's form-based approach, users can begin with simpler forms while familiarizing themselves with the standard. Our experience showed that a physician can learn to read and revise a TMT form with a 10–15-min introduction.

9.4. Future expandability

The form-based design allows different forms in the medical record to be represented in independent schemas. If necessary, new schemas can be added in the future to expand the coverage of the variety of clinical documents.

9.5. Level of localization

Since the TMT standard was designed to accommodate local needs, it satisfies the requirement for region-specific localization.

Technical barriers also affect system implementation due to semantic interoperability among medical facilities. The TMT has very clear definitions of its exchange data contents. So, semantic interoperability can be achieved with the TMT.

10. Discussion

The TMT is a standard that aims to achieve functional and semantic interoperability in EHR exchanges. Through Extensible Stylesheet Language Transformations (XSLT) technology, TMT XML files can be transformed into the HL7 CDA format which can facilitate international interoperability in the future. In order to fit into the current environment, the TMT was designed using forms, a concept already familiar to medical professionals. For the project, we carried out system prototyping, training, and education and tried as much as was possible to ensure that the standard is easy to implement. We have reviewed all relevant laws which might affect EHR exchanges in Taiwan, and the TMT standard can be implemented in a way that complies with all current laws and regulations. The project has achieved the requirements of: (1) being transformable to international medical information standards; (2) having a minimal impact on existing healthcare systems; (3) being easy to implement and deploy; and (4) being compliant with current laws and regulations.

In 2007, the Department of Health (DOH) in Taiwan determined to allocate about US\$1 million to promote the TMT

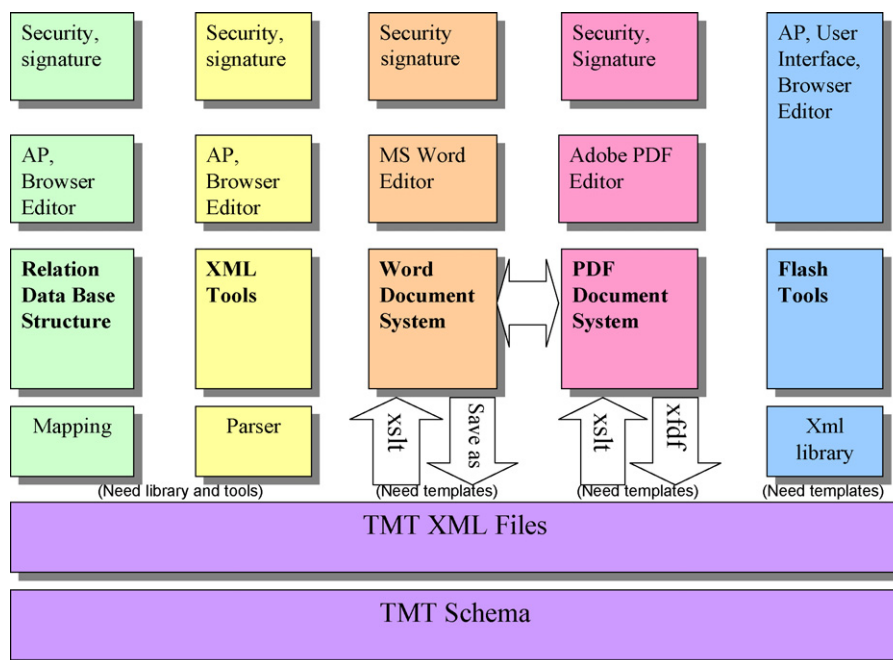

Fig. 8 – Taiwan Electronic Medical Record Template (TMT) document transformation.

format in ten medical centers which collectively provide more than 10 million outpatient visits a year. This project will also help refine the TMT into a national standard for EHR documentation and exchange in Taiwan.

During the past research time, the members of this team acquired many technical skills about XML, such as schema definition, XSLT, XQuery, and XPath languages. We now also better understand HL7 CDA, OpenEHR, ASTM CCR, and the IHE international standard. When we were building and testing an exchange prototype system to communicate among hospitals, we also learned more about technical barriers against semantic interoperability, such as the transfer data from HIS database to XML file.

Because of the maturity of the XML technical standards, such as XSLT, XPath, XQuery, etc., it is easy to transform a required document into a variety of document formats, as shown in Fig. 8. The XML technology is currently the mainstream choice of data packaging [15–17] for sharing information. It is also possible to use XSLT to convert among various medical information standards [18,19]. It is this adoption rate that will ultimately determine whether the standard is retained or discarded.

The design of the TMT format provides the basis for developing a document-based information standard and information interoperability infrastructure for the health-care system in Taiwan. With the help of the TMT, the document-based EHR can also be used for digital signatures and encryption of files that can be delivered to individual patients for personal health management purposes.

Acknowledgments

This research project (DOH no. 95A3310) was made possible with the aid of the Taiwan Association of Medical Informat-

ics and sponsorship of the Information Center, Department of Health, Executive Yuan, Taiwan along with contributions made by all the experts involved in the project.

REFERENCES

- [1] HL7 Health Level Seven, available at <http://www.hl7.org/>, accessed on 20 April 2007.
- [2] IHE IT Infrastructure Technical Framework, http://www.ihe.net/Technical_Framework/index.cfm#IT, accessed on 20 November 2006.
- [3] Paul Miller, Interoperability What is it and why should I want it? <http://www.ariadne.ac.uk/issue24/interoperability/intro.html>, accessed on 30 May 2007.
- [4] R.H. Dolin, L. Alschuler, S. Boyer, C. Beebe, F.M. Behlen, P.V. Biron, S.A. Shabo, HL7 Clinical Document Architecture, Release 2, J. Am. Med. Inform. Assoc. 13 (2006) 30–39.
- [5] R.H. Dolin, L. Alschuler, C. Beebe, P.V. Biron, S.L. Boyer, D. Essin, E. Kimber, T. Lincoln, J.E. Mattison, The HL7 Clinical Document Architecture, J. Am. Med. Inform. Assoc. 8 (2001) 552–569.
- [6] openEHR Archetypes, <http://svn.openehr.org/knowledge/archetypes/dev/index.html>, accessed on 11 May 2006.
- [7] ASTM Committee E31 on Healthcare Informatics develops standards, <http://www.astm.org/cgi-bin/SoftCart.exe/COMMIT/COMMITTEE/E31.htm?L+mystore+fdxl9438>, accessed on 8 December 2006.
- [8] D.C. Kibbe, J. Phillips, L.A. Green, The continuity of care record, Am. Fam. Physician 70 (2004) 1220–1223.
- [9] D. Asuman, B.L. Gokce, K. Yildiray, U. Seda, Exploiting ebXML registry semantic constructs for handling archetype metadata in healthcare informatics, Int. J. Metadata, Seman. Ontol. 1 (2005) 21–36.
- [10] IEEE standard computer dictionary, A compilation of IEEE standard computer glossaries, IEEE Std. 610, 1991.

- [11] Aguilar, A. Semantic Interoperability in the context of eHealth, <http://aguilar.deri.ie/papers/ehealth.paper.pdf>, accessed on 20 November 2006.
- [12] MERIT-9 Project, <http://merit-9.mi.hama-med.ac.jp/>, accessed on 20 November 2006.
- [13] K.U. Heitmann, R. Schweiger, J. Dudeck, Discharge and referral data exchange using global standards—the SCIPHOX project in Germany, *Stud. Health Technol. Inform.* 90 (2002) 679–684.
- [14] XML Schema, <http://www.w3.org/XML/Schema>, accessed on 20 May 2007.
- [15] S.C. Arnott, Effect of XML markup on retrieval of clinical documents, *AMIA. Annu. Symp. Proc.* (2003) 614–618.
- [16] R. Schweiger, S. Hoelzer, K.U. Heitmann, J. Dudeck, DTDs go XML schema—a tools perspective, *Med. Inform. Internet Med.* 26 (2001) 297–308.
- [17] R. Schweiger, S. Holzer, J. Dudeck, Advanced information retrieval using XML standards, *Stud. Health Technol. Inform.* 116 (2005) 677–682.
- [18] J. Mijic, M. Tadic, M. Jancec, and G. Jovanov, HTML to XML conversion for non-programmers, 2005, pp. 329–334.
- [19] E. Wustner, T. Hotzel, and P. Buxmann, Converting business documents: a classification of problems and solutions using XML/XSLT, 2002, pp. 54–61.